









A		M6*70	6	F		1510	18
B		M6	6	G		4*40	12
C		Φ8*30	32	H		4*30	30
D		Φ7*50	6	M		4 mm	1
E			18				



Part No.	Part Name	Material	Quantity	Dimensions	Notes
1	Front Panel	Steel	1	400x600	
2	Side Panel	Steel	1	400x600	
3	Top Rail	Steel	2	400x20	
4	Main Body	Steel	1	400x600	
5	Slats	Steel	10	400x10	
6	Support Bar	Steel	1	400x20	
7	Support Bar	Steel	1	200x20	
8	Support Bar	Steel	2	400x20	
9	Support Bar	Steel	1	200x20	
10	Support Bar	Steel	1	400x20	
11	Drawer	Steel	2	400x200	
12	Support Bar	Steel	2	400x20	
13	Support Bar	Steel	2	200x20	
14	Support Bar	Steel	2	400x20	
15	Support Bar	Steel	2	200x20	

STEP:1

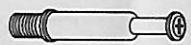
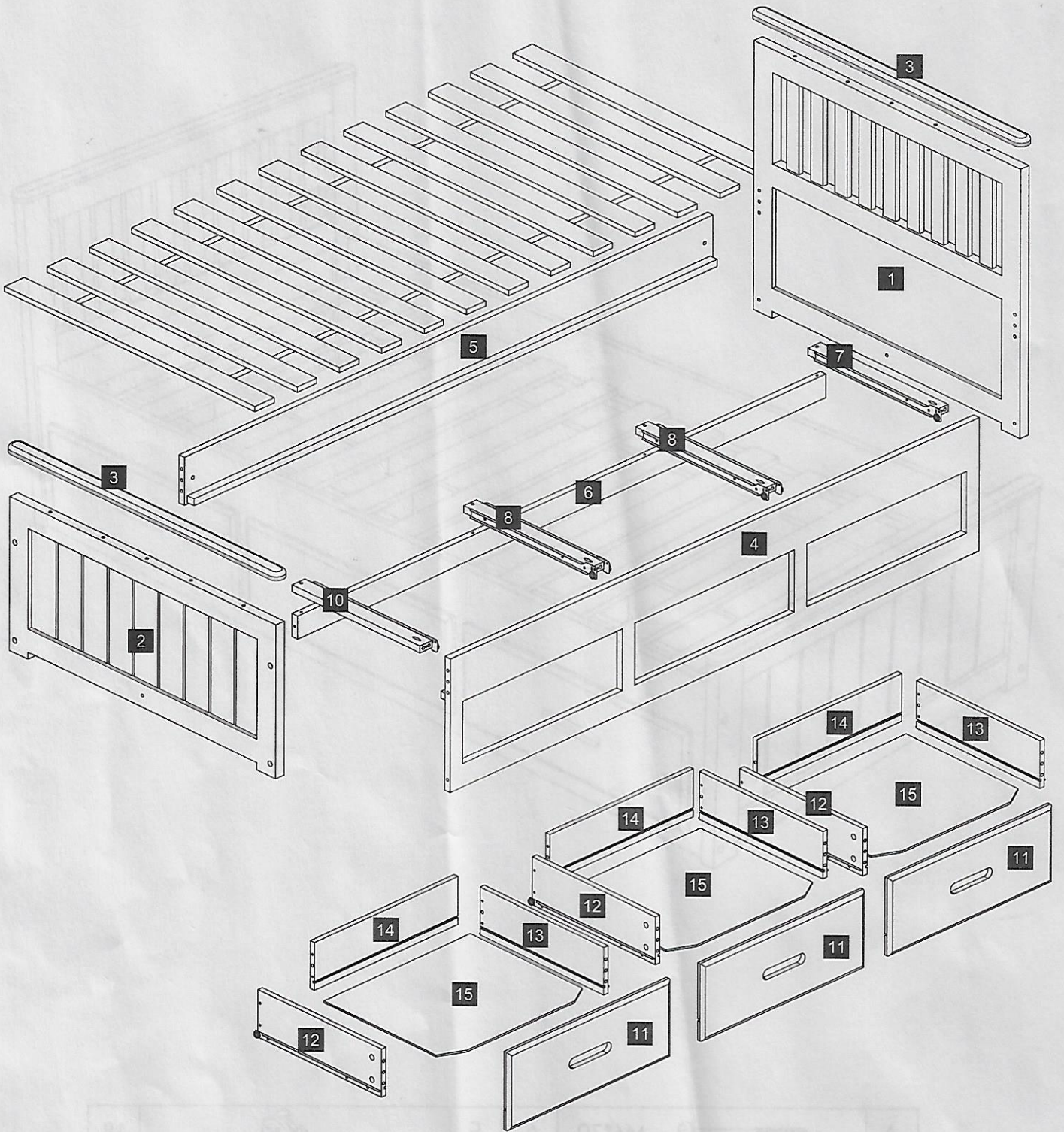
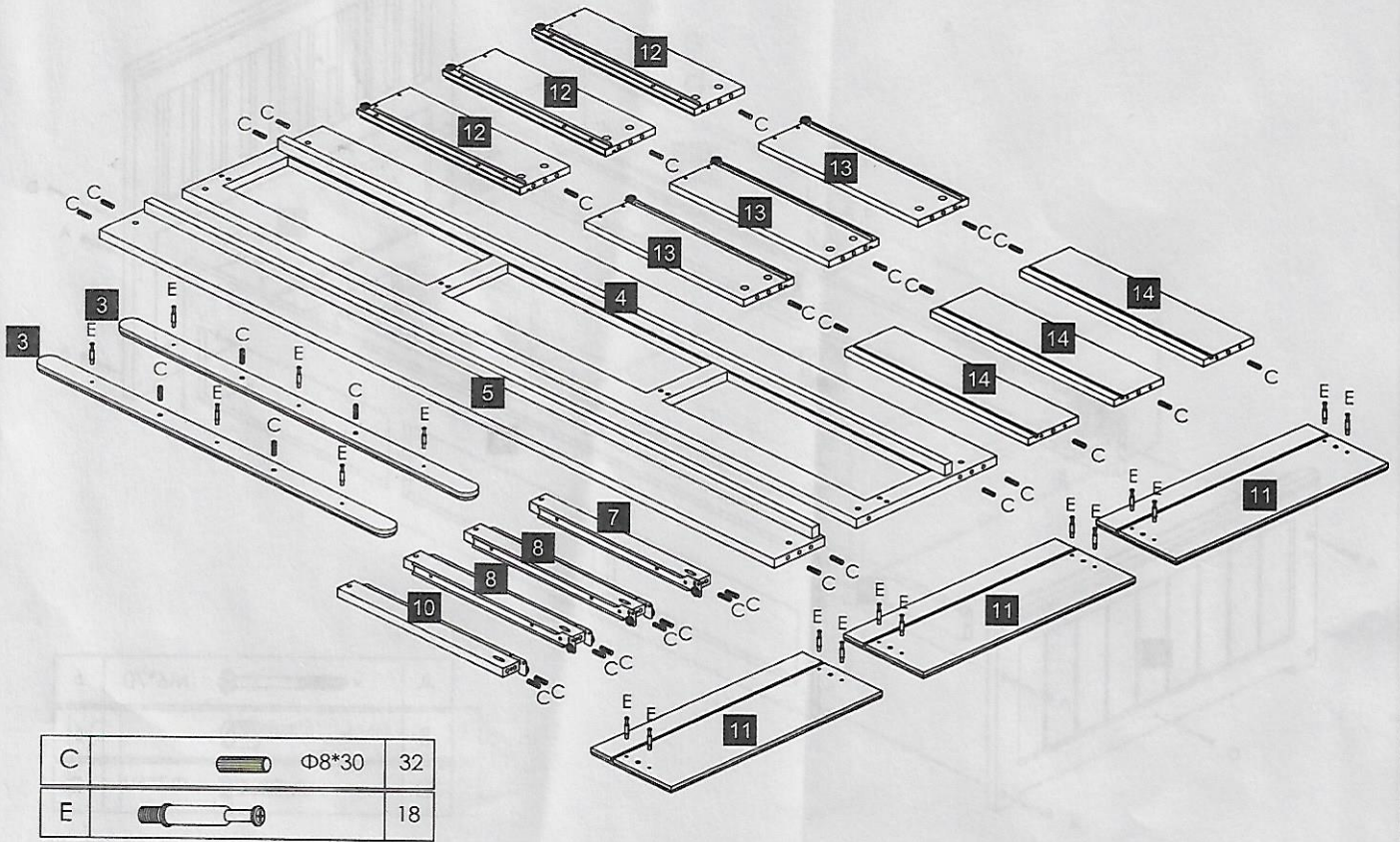

STEP:2

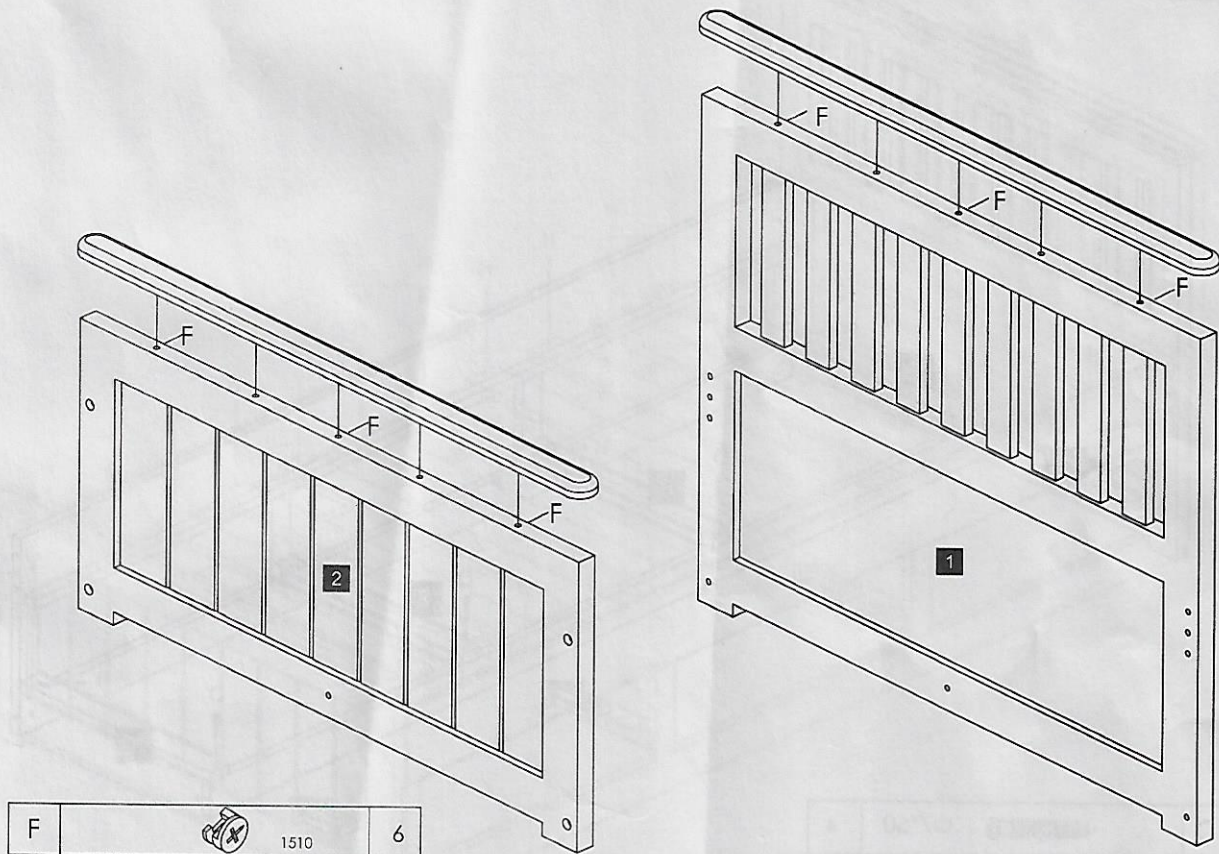

STEP:3

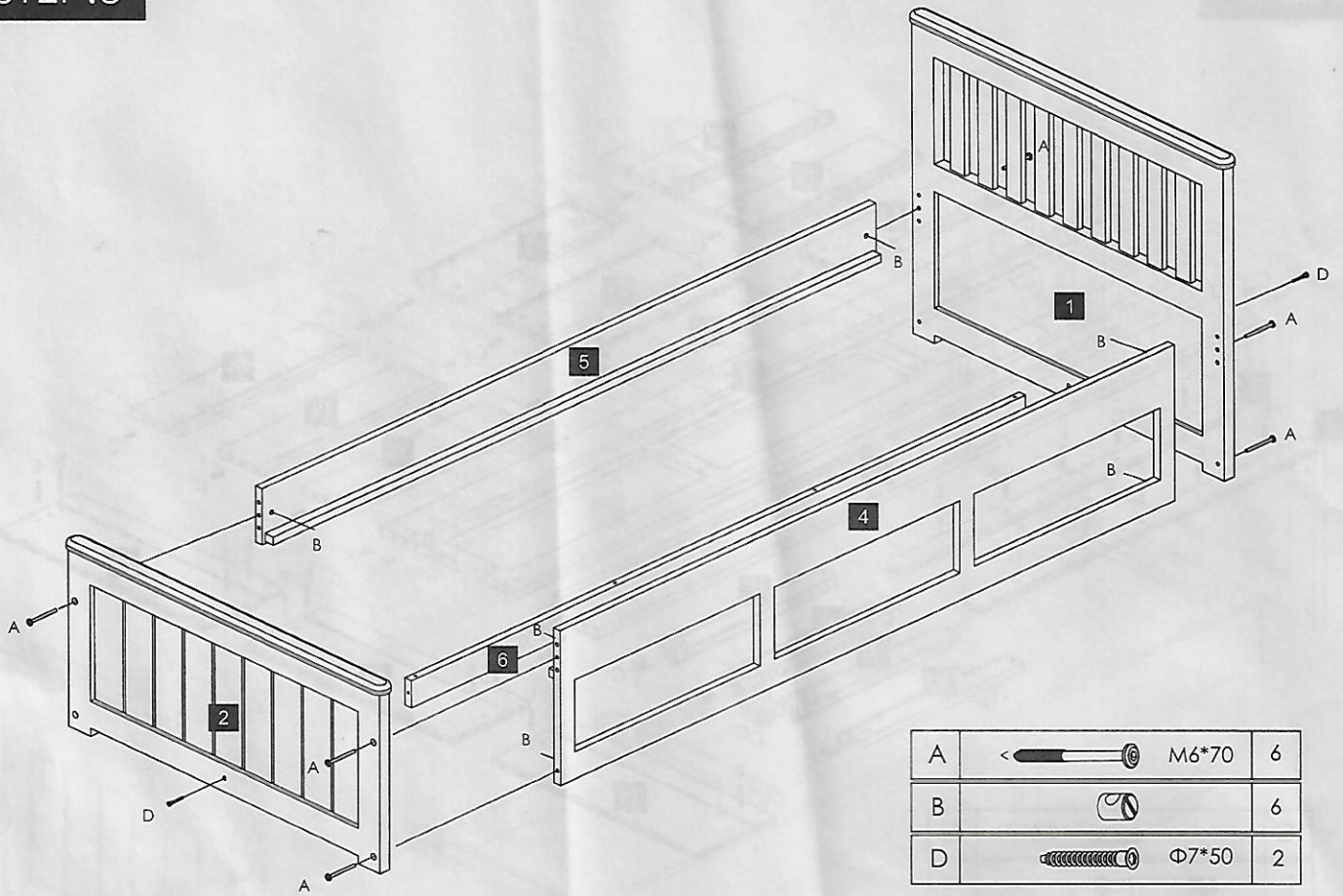

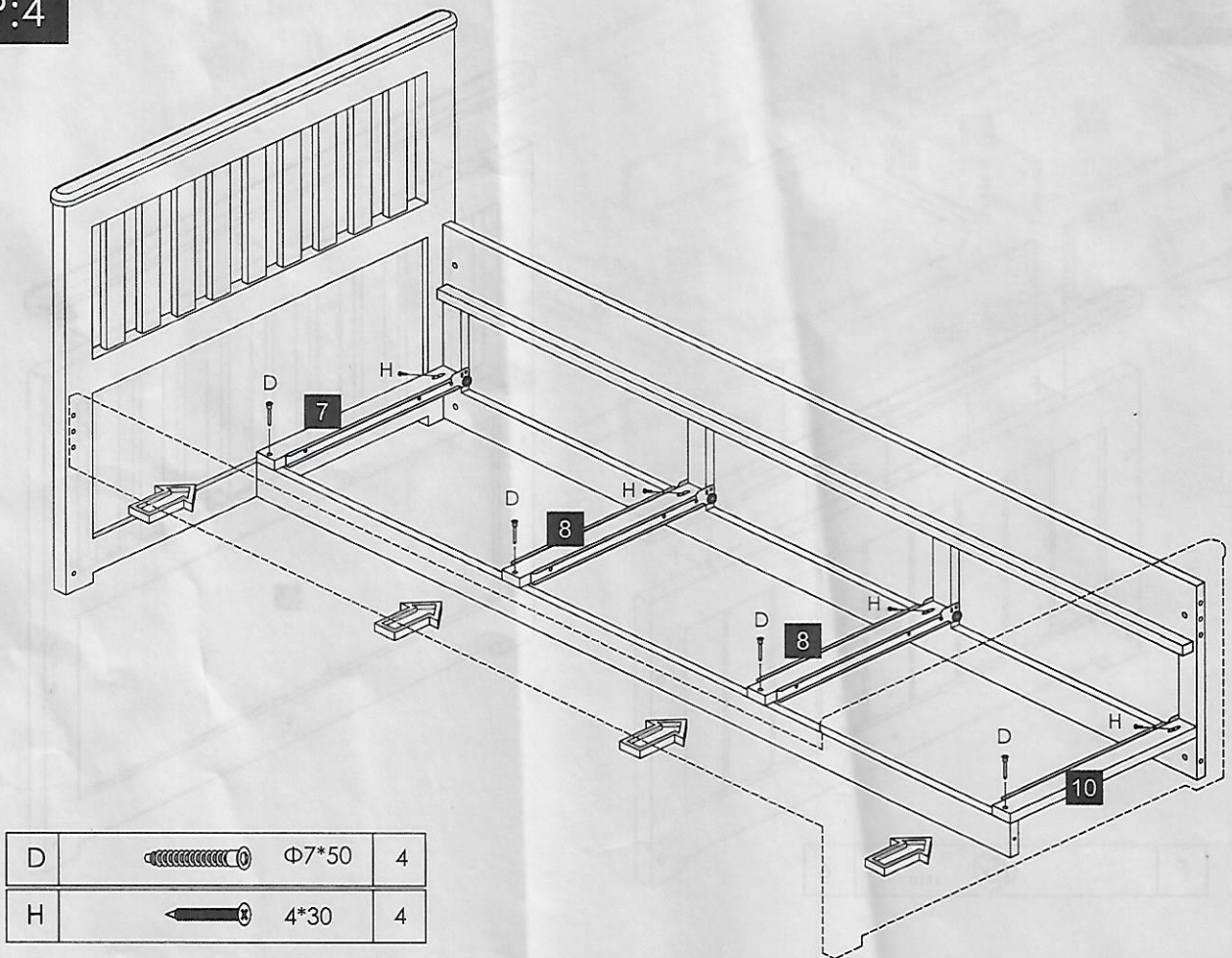

STEP:4

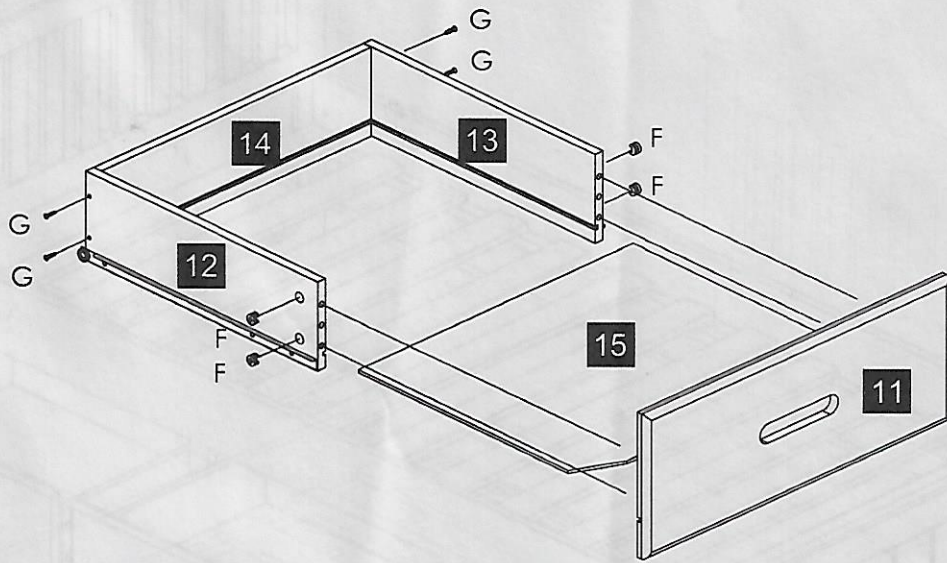

STEP:5 3 x



G		4*40	12
F		1510	12

STEP:6

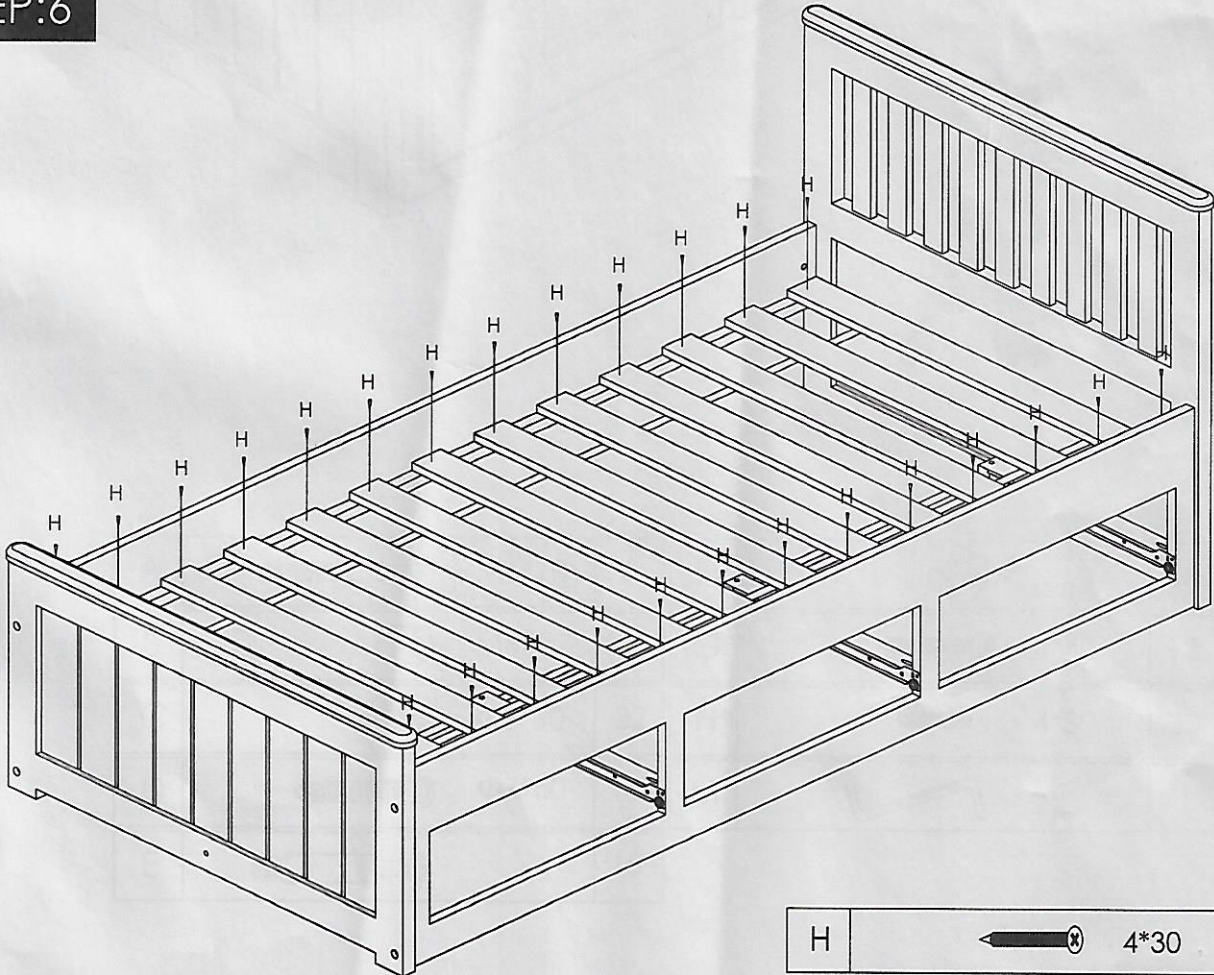

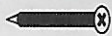
H		4*30	26
---	---------------------------------------------------------------------------------------	------	----

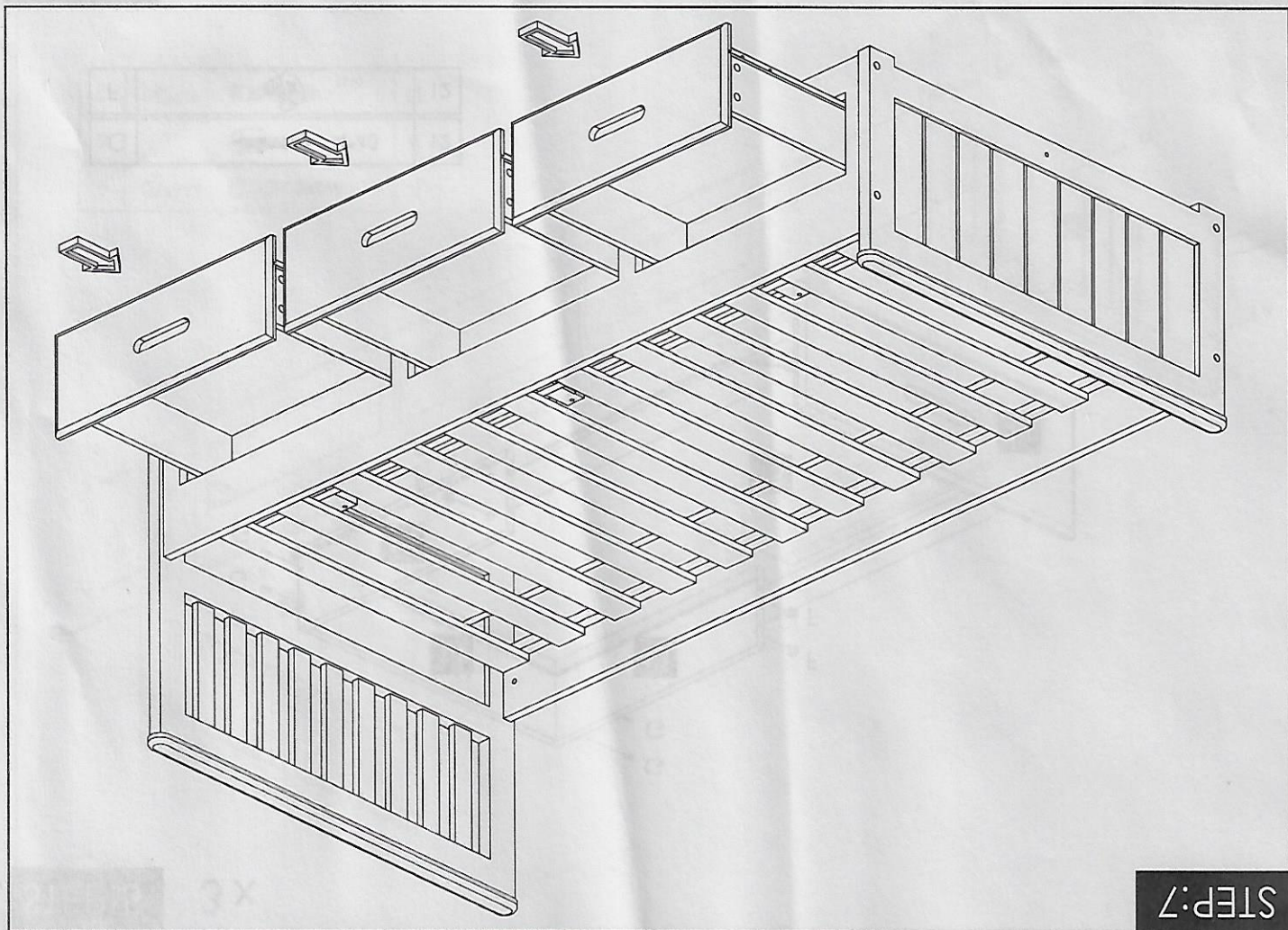
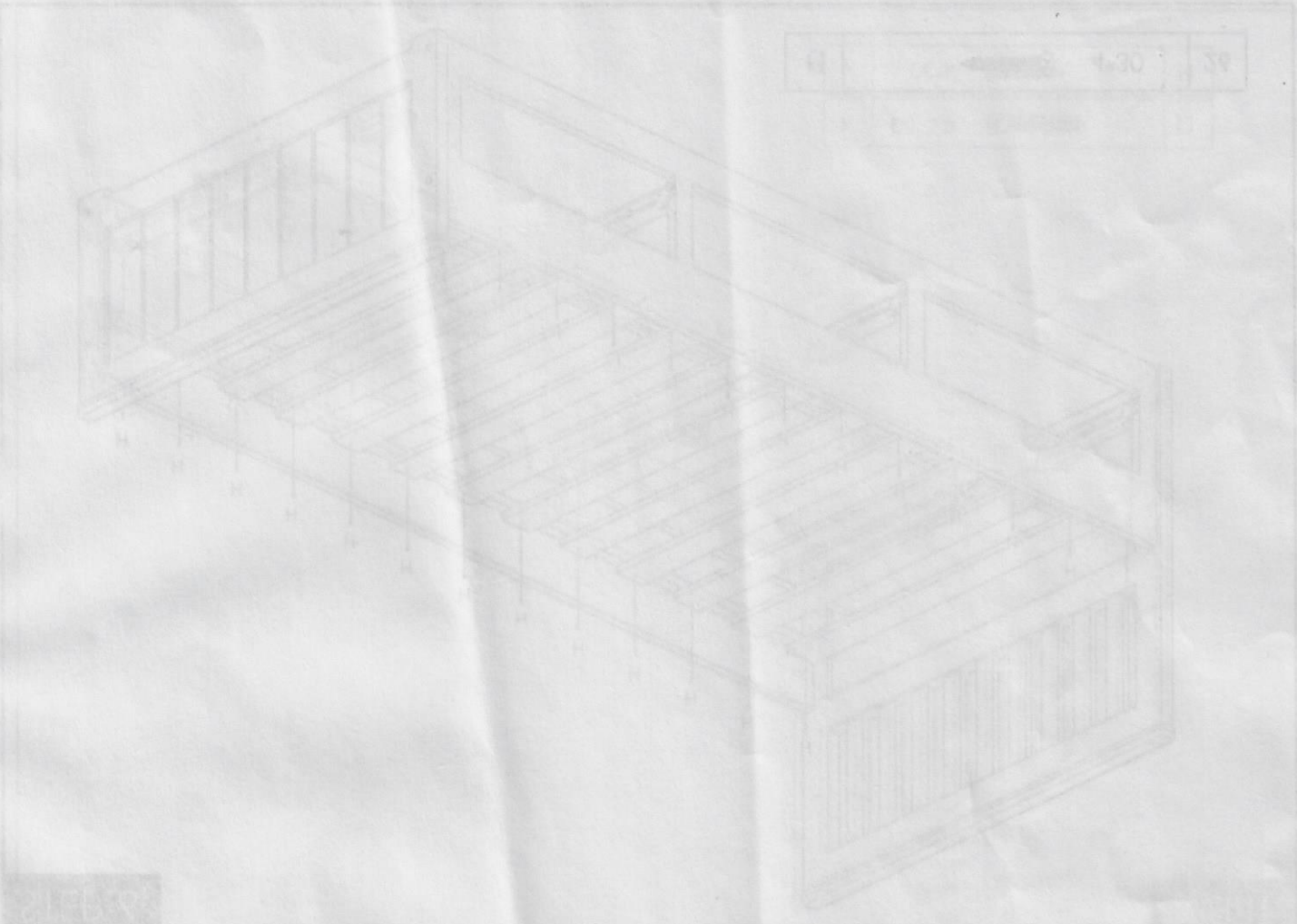

STEP:7