

Parts

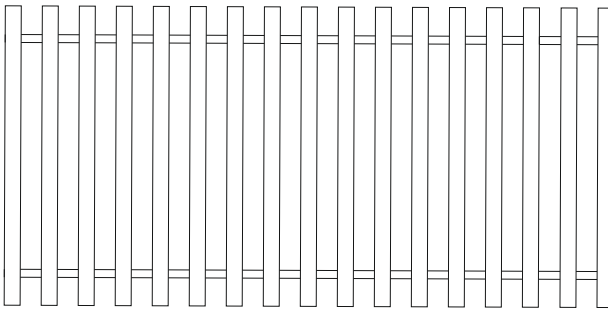

Fittings

4 x nuts, 4 x washers, 4 x spring washers & 4 x threaded bars

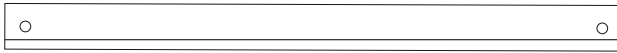
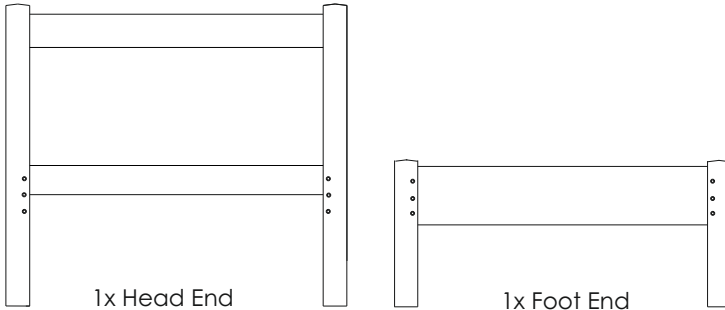
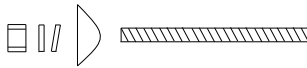

8 x Dowels



30 x Screws



Tools Req

Screwdriver

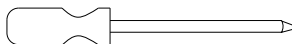

Spanner

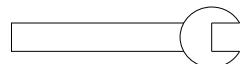

Fitting the bed legs.

4 threaded bars and 8 wooden dowels

Insert and rotate each threaded bar into the centre hole on each bed leg. Now insert the wooden dowels into the two holes either side.

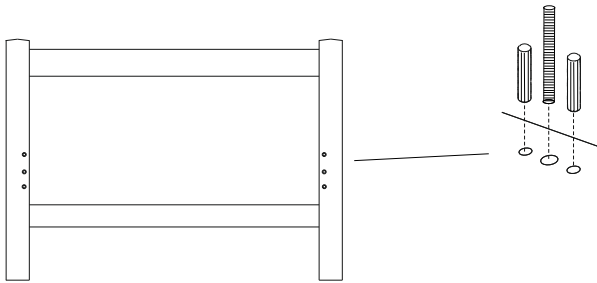

Making the bed. (Two people required)

Slide each mattress rail onto the threaded bar and wooden dowels that you have fitted in the legs. Carefully slide the lunar washer onto the threaded bar as it passes through the large hole in each mattress rail. As this bar passes through the lunar washer slip on the spring washer then the normal washer and then finally the nut. Push the bed frame together. Rotate the nut using the spanner provided and tighten the bed frame.

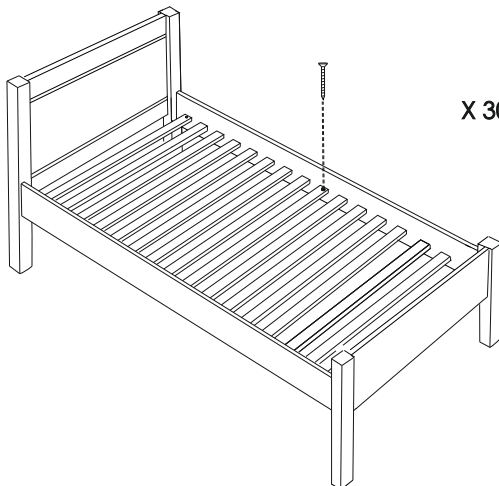
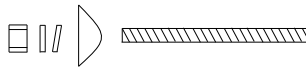
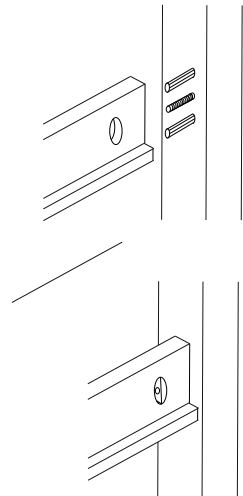

X 30



Fix the base

30 x Wood screws

Lift the slatted base onto the bed, slide out and screw down.

Note: Both bed end slats should be tightly fitted at each end.